

MANTIS

Ergonomic stereo microscope

Vision
ENGINEERING
www.visioneng.com



FOCUSED | QUALITY

MANTIS

THE stereo microscope for **performance**

Mantis is THE stereo microscope brand trusted by thousands of customers globally to deliver excellent high quality images for a wide range of magnification applications, in an easy to use ergonomic system.



The Mantis advantage delivers six key benefits:

1. Unique large high quality optical stereo image

See the finest detail in a large, high resolution, high contrast optical stereo image. Whether you are viewing your subject in the eyepiece-less viewer or a separate monitor, Mantis delivers the superior image quality you need to perform your inspection tasks accurately and quickly.

2. Ergonomic design for user comfort and productivity

Ergonomically designed Mantis enables relaxed, stress-free viewing and manipulation of your component or sample, improving posture whilst reducing back and neck strain. Additionally, the eyepiece-less design reduces eye activity, and thus eye strain. 'No touch' viewing means systems can be operated by multiple colleagues without the risk of cross-contamination.

3. 5 different ways to illuminate your subject

5 separate illumination methods enable superior control of your subject lighting for optimal inspection of a wide range of different materials. Control and eliminate shadows from your image.

4. Suitable for a wide range of applications

Long working distance and excellent depth perception makes Mantis perfect for multiple applications including; electronics, medical device manufacture, precision engineering, life science, and many more.



5MP image quality



Long working distance



Ergonomic position



3D view



Overlay & Image comparison



Import, export settings



Glasses free



Outstanding image quality



3D illumination



5. Mantis PIXO – Digital imaging for collaboration, traceability and training

PIXO combines optical and digital technologies, providing perfect synergy between the optical stereo view and a high resolution camera. Capture, review and share detailed images for traceability, collaboration and training. Add text, shapes, arrows or digital overlays. Compare live images with targets, measures or pre-set guides.

6. Versatility

Whatever you need to magnify or work on, Mantis is THE stereo microscope to use. Manipulate your subject easily with long working distance, accurate 3D view, and quick magnification change. A choice of 3 models ensures you get the functionality you need to complete your tasks, with maximum accuracy, efficiency and comfort.



Mantis – World leading technology, for the next generation.

MANTIS

THE stereo microscope for **image quality**

Mantis optical stereo microscope delivers an unrivalled high quality 3D image, rich in detail and contrast, perfect for 3D observations and manipulation of a wide range of subjects.



Eyepiece-less design

The eyepiece-less technology of Mantis projects a large, high quality optical stereo image directly into the user's eyes.

This makes the image much easier and more comfortable to view compared with traditional microscopes.

The unique image quality presented by Mantis is a result of bespoke lenses and optics, tailored to each system.

The clarity of the 3D image supports enhanced hand-eye coordination, making subject manipulation with tools more accurate, faster and more efficient.

Custom Optics

To ensure the highest image quality for the user, each lens is tailored to the Mantis system, combining finest optical quality glass and special coatings to give a high resolution, high contrast view.

For the most demanding subjects there is also a range of Super Long Working Distance (SLWD) objective lenses.

Dynamic View Optics

Mantis's large, clear image enables the operator to have a range of head movement whilst viewing the subject, giving them the opportunity to look 'around' the subject rather than just straight down on it.

This 'dynamic view' improves visual understanding, enabling a view of the sides of features, thereby presenting a much greater level of information than a traditional microscope.

The exit pupil of the Mantis (the diameter of the beam received by the users eyes) is ten times the size of the exit pupil from standard microscope eyepieces, delivering a superbly clear and easy to view image.

High performance digital imaging

Use Mantis PIXO's high quality camera to share your image to a screen. Improve reporting and communication effectiveness with Mantis PIXO, which enables you to capture, review and share high

quality images, including annotations, in real time. Maximise working effectiveness by adding digital overlays to compare live images with targets, measures or pre-set guides.



MANTIS

THE stereo microscope for ergonomics

The ergonomic design and operation of Mantis benefits the user in five key ways. This combination of benefits includes postural comfort, maximised eye comfort, improved hand-eye coordination, ease of use, and the perfect stereo view, and collectively enable higher levels of accurate, comfortable, and productive user performance for longer periods of time.

Postural comfort

Patented eyepiece-less technology delivers a large image at a position in which the operator sits upright to view. This is a major advantage over traditional microscope image viewing positions, and reduces

strain on the operator's back, neck, and shoulders. Additionally, because the image is comparatively large, the user's head is not required to be in a fixed position, also improving working comfort.



Hand-eye coordination

The distinctive stereo view of Mantis gives users access to both the direct view of the subject, and also to their peripheral vision. This enhanced view helps users to understand the shape and form of the subject, and also the position of the tools they are using to work on the sample.

Sample manipulation using tools can be carried out with higher levels of accuracy and confidence.



Maximised eye comfort

The distance from the Mantis to the user's eye allows access to ambient light, reducing iris activity when working.



Users can wear corrective or protective eye glasses with no loss of performance.

No eyepieces and simple controls which can be operated whilst wearing hand protection, supports 'no-touch' viewing. The separation from the system to the user's eye reduces the risk of cross contamination and eye infection.

Mantis can be shared between multiple operators more safely, reducing operator risk. Mantis can be used in otherwise inaccessible environments such as laminar flow cabinets.

Easy to use

Mantis has few, simple to operate controls to ensure that every user quickly and effectively becomes confident with the instrument. For example - need to change view? Rotating the multi-view turret allows three different magnifications of your subject with a simple operation.



Perfect stereo view every time

The simple inter pupillary distance (IPD) control ensures that every user has the perfect stereo view, every time. Simply rotate the control until the binocular image aligns with your eyes.



MANTIS

THE stereo microscope for **5-way illumination**

Mantis features 5 different illumination modes, giving you maximum control over lighting your subject. This ensures you achieve the best possible shadow-free illumination of your sample for the best quality inspection and manipulation.

Dynamic 3D illumination

Mantis features two banks of LEDs which can be set for synchronised or independent operation. Controlling each bank independently gives you the option to add shadow detail, enhancing your 3D understanding of the subject. Additionally it helps prevent unwanted reflections, which can hide subject detail.



Transmitted illumination

Lighting from below enables more accurate inspection of transparent, translucent and perforated subjects.

Choose Stabila stand with built in sub-stage illuminator for a simple but effective solution to your transmitted lighting requirements.

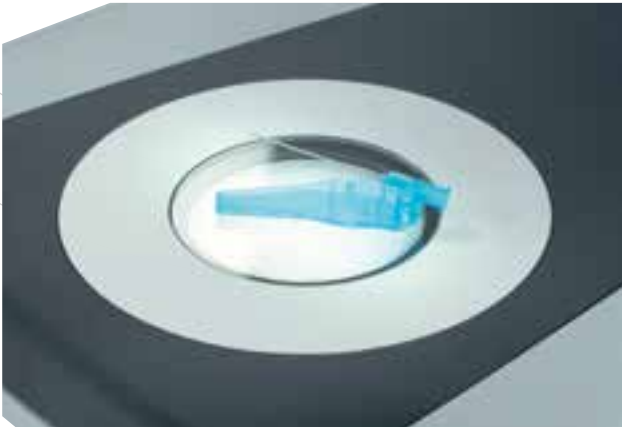

EPI illumination

Useful when inspecting component cavities and internal cylinder surfaces (e.g. thread inspection). The episcopic illuminator ensures that the cavity is fully lit by sending light along the same path that the Mantis viewer sees it. If the viewer can see it, it is illuminated, improving inspection capability.



White/UV illumination

Choose White/UV illumination for applications such as clearcoat validation on printed circuit boards to ensure even coverage.

Easily change from one light to another to view the coating itself, and then through the coating.

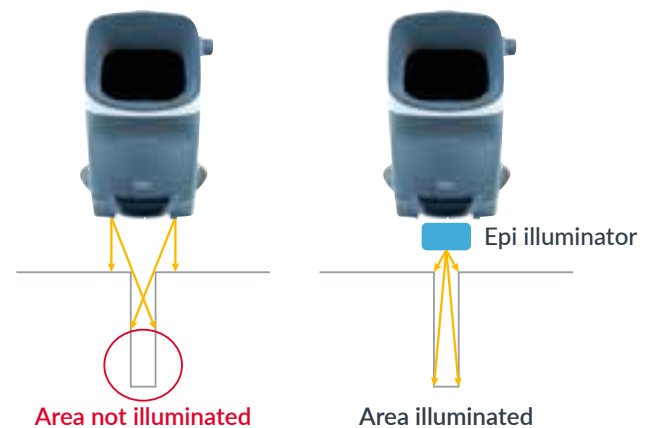

Contrast enhancing lighting

For more challenging subjects such as plastics, glass, biological samples and other transparent or translucent materials, Mantis offers contrast enhancing lighting via its optional adjustable contrast enhancing base.

Adjust shutter, angle of illumination and intensity for greater light control, highlighting edges and key details within the subject.



MANTIS

THE stereo microscope for a range of applications

Perfect for any application requiring magnification up to 15x where you would otherwise use a bench magnifier or traditional stereo microscope. Mantis is designed for accuracy in the industrial or academic workplace, and is ideal for quality inspection of assemblies, repairs and reworks, sample preparation, dissection and more. Mantis is the 3D stereo microscope of choice for industries including electronics, medical device manufacture, precision engineering, life science, aerospace, automotive, and manufacturing.

Wide range of applications

Electronics

Improved hand-eye coordination and lower operator fatigue makes tasks such as soldering, PCB inspection and rework easy, especially for extended periods.

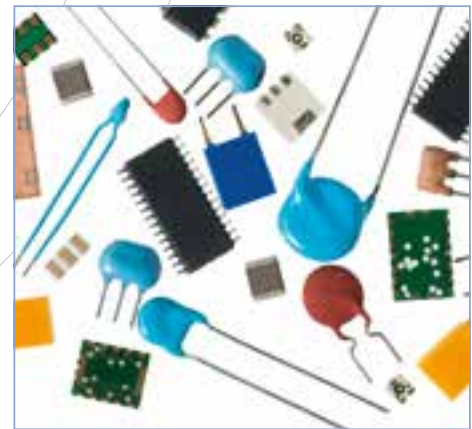

Precision engineering

Mantis' clear stereo view and low operator fatigue make it perfect for precision engineering inspection tasks such as component finishing, anodising or hardening defect detection, and tasks which need the use of tools, such as deburring.

Medical

Bright imaging and ease of use makes Mantis a great choice for the inspection of stents, catheters and other medical products.





Laboratories and life sciences

High-concentration applications which require long periods of intense focused working, such as sample preparation, dissection and manipulation can be performed in comfort.

Safety glasses can be worn, and Mantis stereo microscope can be used effectively in a laminar flow cabinet.

Plastics and rubber

Mantis makes the quality control of rubber seals and plastic components – and inspection and rework, such as the removal of flash and other injection moulding defects – easier and quicker.



Dental

Mantis is a good choice for precision work such as tailoring dental prosthetics which requires magnification for inspecting the moles, for rework and colour-matching the final product.



Watchmaking and jewellery

Depth perception and hand-eye coordination make Mantis ideal for watch and jewellery making. Assembly and finishing of the smallest movements or the setting of stones is done with confidence and precision.



UV Fluorescing Coatings and Dyes

Mantis is ideal for working with UV fluorescing subjects. Coatings, dyes, masking and other subjects can be viewed with white light or excited with UV illumination to fluoresce and viewed easily by the user.

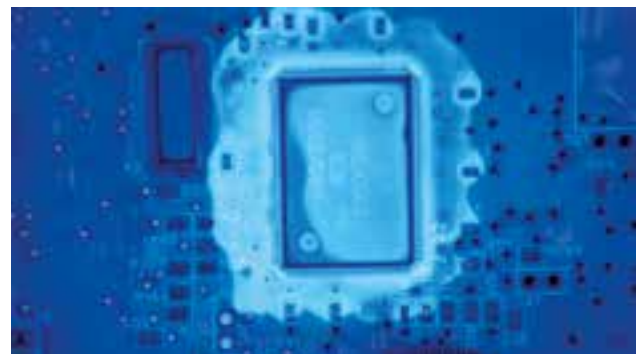

MANTIS

THE stereo microscope for **versatility**

The Mantis family consists of three models, PIXO, ERGO and IOTA, giving you the ability to choose the right option for your requirement. Whether you need a full featured inspection system supporting video and image capture, annotation, display of custom overlays; a multi-view optical only system with magnification up to 15x, or a simple compact system with up to 8x magnification, Mantis is the right system for you.



MANTIS PIXO

Eyepiece-less optical stereo microscope with integrated digital camera and dynamic view optics.

Key features

- high quality optical stereo image
- ergonomic working position
- long working distance
- integrated high-definition camera
- video and image capture
- on screen annotation
- custom overlays
- magnification 3x – 15x
- 3 lens multi-view turret
- dynamic 3D lighting
- white/UV lighting option



MANTIS ERGO

Eyepiece-less optical stereo microscope with dynamic perspective optics.

Key features

- ❑ high quality optical stereo image
- ❑ ergonomic working position
- ❑ long working distance
- ❑ magnification 3x – 15x
- ❑ 3 lens multi-view turret
- ❑ dynamic 3D lighting
- ❑ white/UV lighting option



MANTIS IOTA

Compact eyepiece-less optical stereo microscope with dynamic perspective optics.

Key features

- ❑ high quality optical stereo image
- ❑ ergonomic working position
- ❑ long working distance
- ❑ magnification 3x – 8x
- ❑ interchangeable lenses
- ❑ synchronised LED lighting

Your choice of objectives

Select the objectives most suitable for your application. Super long working distance objective lenses available for when the maximum working distance is required.



MANTIS

Stand Options

Stabila stand

Counter Sprung for ease of use, Stabila's compact, stable design features a long range of focus travel, and an optional illuminated base.

Dimensions	PIXO	ERGO	IOTA
A (Workbench to top of the head)	513-663mm		449-559mm
B (Throat, optical axis to column)	218mm		218mm
C (Length)	422mm		422mm
D (Width)	290mm		290mm
E (Top of stabila to bottom head/objective)	246mm max		239mm max

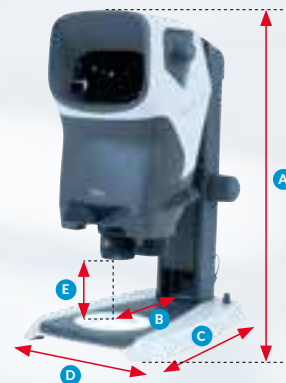

Stabila stand with pilot stage

Pilot Stage - 100mm x 100mm travel stage with autolock to prevent unwanted movement.

Dimensions	PIXO	ERGO	IOTA
A (Workbench to top of the head)	513-663mm		449-559mm
B (Throat, optical axis to column)	218mm		218mm
C (Length incl. movement)	475mm max		475mm max
D (Width incl. movement)	520mm max		520mm max
E (Top of stabila to bottom head/objective)	212mm max		205mm max

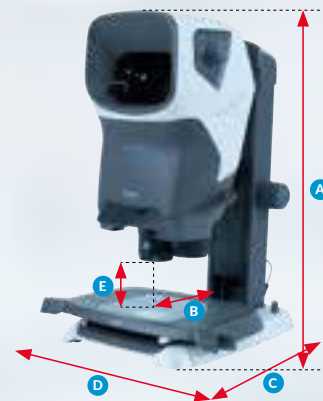

Verso arm

Versatile 'lift and lower' Verso stand enables Mantis to be swung in and out of position when needed.

Dimensions	PIXO	ERGO	IOTA
A (Workbench to top of the head)	429-652mm		360-590mm
B (Throat, optical axis to column)	380-505mm		375-503mm
C (Length)	575-695mm		590-710mm
D (Worksurface to bottom head/objective)	40-285mm		39-263mm



Verso arm with forearm

Adds extra stand reach with pivot point, rotation 270°.

Dimensions	PIXO	ERGO	IOTA
A (Workbench to top of the head)	482-710mm		416-639mm
B (Throat, optical axis to column)	630-755mm		630-750mm
C (Length)	825-945mm		840-960mm
D (Worksurface to bottom head/objective)	106-337mm		94-316mm

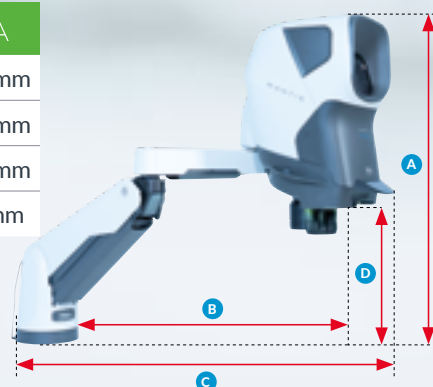

MANTIS

Technical Specification

	PIXO				ERGO				IOTA			
Optical	Values below are for both PIXO and ERGO								Values below are for IOTA			
Compatible Objective Lens	x3	x4	x6	x8	x10	x15	x6 SLWD	x8 SLWD	x3	x4	x6	x8
Max. Working distance (mm)	100	100	68	60	54	40	114	113	104	108	74	61
Measured Max FoV (mm)	44.1	35.7	24.2	18	14.2	9.1	22.5	17.9	37.0	29.0	20.1	15.0
Pupil Diameter (mm)	23.5	23.6	22.4	19.4	17.0	12.3	17.0	14.4	22.8	23.6	22.0	18.0

	PIXO				ERGO				IOTA			
Illumination	Values below are for both PIXO and ERGO								Values below are for IOTA			
Incident options												
- Brightness	~21 k lux max								~26 k lux max			
- Colour temp	5500K at max brightness								5500K			
- Control	25 steps								25 steps			
Transmitted (Stabila illuminated base)												
- Brightness	36 k lux max								36 k lux max			
- Colour temp	~4800K								~4800K			
- Control	25 steps								25 steps			
White / UV version												
- Brightness	White: 11k lux				UV: 0.47 k lux 53 uW/cm ² Max				—			
- Peak wave length	385nm								—			
- Control	25 steps								—			

	PIXO				ERGO				IOTA			
Size (Head only)												
Depth (mm)	275				275				271			
Width (mm)	218				218				196			
Height (mm)	371				371				324			
Weight												
Max. operating (kg)	6.5				6.4				3.5			
Head only (kg)	4.5				4.4				3.2			
Camera (PIXO only)												
Camera resolution (MP)	5.04 MP				—				—			
Best capture resolution (pixels)	2592 x 1944				—				—			
Frame refresh rate	48 frames per second				—				—			
Sensor type	Rear-illuminated CMOS				—				—			
Colour depth	12-bit				—				—			
Interface	SuperSpeed USB 3.0				—				—			
Output connection	USB-C to PC				—				—			
Supplied software	ViCapture				—				—			
Optional software	ViFox DimensionOne DimensionTwo ViPlus				—				—			
Image capture formats	PNG, BMP, JPG				—				—			
Saved image sizes (MB)	PNG - 19Mb BMP - 19Mb JPG - 400Kb				—				—			

Please contact your Vision Engineering branch, local authorised distributor, or visit our website: www.visioneng.com

Sales Partner



Disclaimer – Vision Engineering Ltd. has a policy of continuous development and reserves the right to change or update, without notice, the design, materials or specification of any product, the information contained within this brochure/datasheet and to discontinue production or distribution of any of the products described. E&OE: Errors and omissions excepted.

LIT5500EN-01 | Copyright © 2023 Vision Engineering Ltd. | All rights reserved.

Vision Engineering Ltd.
(UK Manufacturing & Commercial)
The Freeman Building, Galileo Drive, Send, Surrey, GU23 7ER, UK
T +44 (0) 1483 248300
E generalinfo@visioneng.co.uk

Vision Engineering Ltd.
(NA Manufacturing & Commercial)
570 Danbury Road, New Milford, CT 06776, USA
T +1 (860) 355 3776
E info@visioneng.com

Vision Engineering Technology Centre
16 Technology Drive, Unit 148, Irvine, CA 92618, USA
T +1 (800) 644 7264 (Toll Free)
E info@visioneng.com

Vision Engineering Ltd.
(Central Europe)
Anton-Pendele-Str 3, 82275 Emmering, Deutschland
T +49 (0) 8141 40167-0
E info@visioneng.de

Vision Engineering Ltd. (France)
ZAC de la Tremblaie, Av. de la Tremblaie 91220 Le Plessis Paté, France
T +33 (0) 160 76 60 00
E info@visioneng.fr

Vision Engineering Ltd. (Italia)
Via G. Paisiello 106 20092 Cinisello Balsamo MI, Italia
T +39 02 6129 3518
E info@visioneng.it

Nippon Vision Engineering (Japan)
272-2 Saedo-cho, Tsuduki-ku, Yokohama-shi, Kanagawa 224-0054, Japan
T +81 (45) 935 1117
E info@visioneng.jp

Vision Engineering (China)
Room 904B, Building B, No. 970, Nanning Road, Xuhui Vanke Center Shanghai, 200235 P.R. China
T +86 (0) 21 5036 7556
E info@visioneng.com.cn

VE Quality Instrumentation Private Limited
B-803 Sagar Tech Plaza, Andheri Kurla Road, Sakinaka Junction, Andheri East - Mumbai 400072
E info@vequality.in

Vision Engineering (South East Asia)
P-03A-20, Implan Meridian, Jalan Subang 1, USJ 1, 47600 Subang Jaya, Selangor Darul Ehsan, Malaysia
T +604 619 2622
E info@visioneng.asia

Vision Engineering (Latin America)
E info@visioneng.com

Vision Engineering (Mexico)
T 800 099 5325
E info@visioneng.com

Vision Engineering Ltd. (Brazil)
E info@visioneng.com.br



FM 557119

Vision Engineering Ltd. has been certified for the quality management system ISO 9001:2015 and calibration accreditation ISO 17025:2017.